

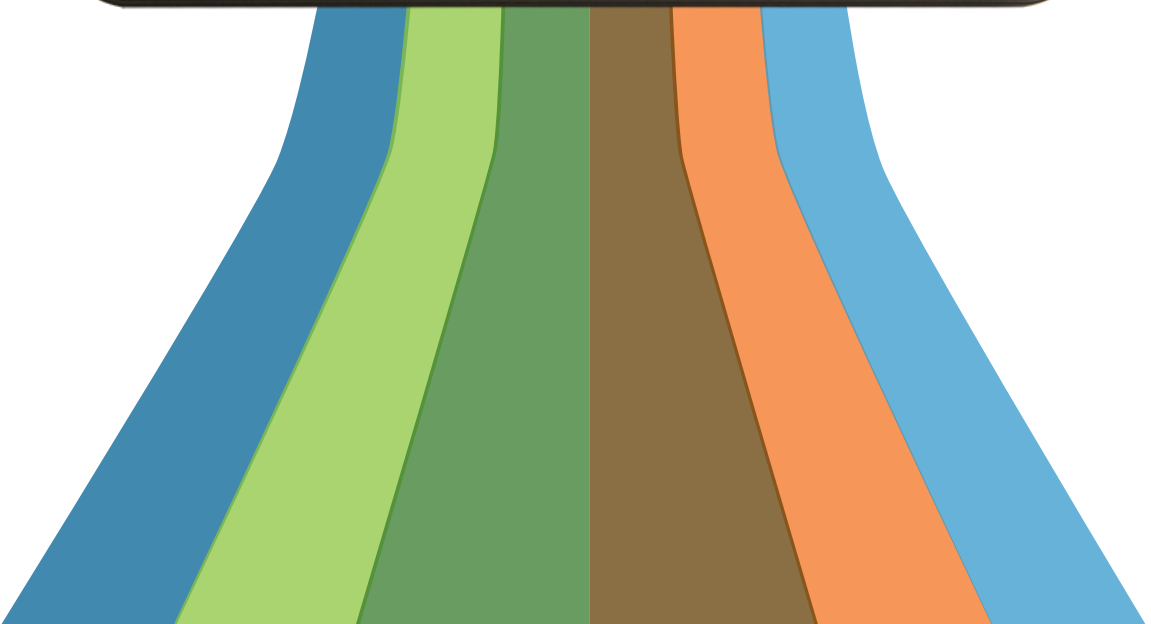

Ag Leader[®]

PRODUCTS & SERVICES

Ag Leader[®]





YOUR OPERATION, IN EVERY SEASON:
CONNECTED.

Ag Leader[®]



Guidance & Steering

pg.8



Planting

pg.10



Application

pg.12



Harvest

pg.14



Water Management

pg.16



Data Management

pg.18

InCommand[®]



THE POWERFUL DUO

ALL CONNECTED.

AgFiniti and InCommand work together to connect all your machines, displays, and devices with the latest information across the farm.



 Year-round functionality

 Split-screen capability

 Row-by-Row mapping

 Wireless connectivity across your farm

 Sync all your displays and devices

 Live maps and stats from the field

 View displays remotely

 Display-to-display communication

 Multi-year analysis and queries

 Easily generate prescriptions



CREATE YOUR OWN PACKAGE

Discover the perfect package
for your operation by visiting
www.agleader.com

DISPLAY FEATURE COMPARISON

InCommand 1200



InCommand 800



Compass



DISPLAY FEATURES

Display Size	12.1"	8.4"	7"
Swipe Gesture	✓	✓	
Split Screen	✓		
Headlands	✓	✓	✓
Multiple Product Control	Up to 8	Up to 3	
Camera Support	4	4	
AgFiniti	✓	✓	
DisplayCast	✓	✓	
Prescription Scaling	✓	✓	
Remote Viewing	✓	✓	

GUIDANCE & STEERING

Lightbar Guidance	✓	✓	✓
Mechanical Assisted Steering	✓	✓	
Hydraulic Automated Steering	✓	✓	
GLIDE, SBAS (WAAS/EGNOS), TerraStar, RTK	✓	✓	✓
SmartPath	✓	✓	✓
Tramlines	✓	✓	✓
StableLoc	✓	✓	✓

PLANTING/SEEDING

Hybrid/Variety Logging	✓	✓	
Variable Rate Planting	✓	✓	
Planter Section Control (AutoSwath)	36 sections	36 sections	
Split-Planter Logging	✓	✓	
Planter Population Monitoring	✓		
Advanced Seed Monitoring	✓		
Hydraulic Down Force Logging	✓		
Row-by-Row Planter Performance	✓		
SureDrive, SureForce, SureSpeed Support	✓		

APPLICATION CONTROL

Liquid Product Application Control	✓	✓	
Liquid Section Control (AutoSwath)	36 sections	36 sections	
Variable Rate Application	✓	✓	
Chemical Injection	✓	✓	
Boom Height Control	✓	✓	
SmartReport	✓		
AutoSwath Based on Previously Applied Maps	✓	✓	
Container Sequencing	✓		
Dry Product Application Control	✓	✓	
Closed Loop Spinner Speed Control	✓	✓	
Strip-Till	✓	✓	
Air Seeder Support	✓	✓	
OptRx Crop Sensors	✓		
ISOXML Data Export	✓	✓	

YIELD MONITORING

Grain Harvest	✓	✓	
Harvest Variety Tracking	✓		
Load Variety Maps	✓		

WATER MANAGEMENT

Topography Mapping	✓	✓	
Survey Collection	✓	✓	
Intellislope Plow Control	✓		

ISOBUS

Universal Terminal Support	✓	✓	✓
Task Controller	✓	✓	



WORK MORE, STRESS LESS

GPS & Steering



From entry level, up to the most accurate steering system on the market, Ag Leader offers a solution for every operation.

Unmatched Steering Accuracy:



GPS 6000, GPS 7500:

Ag Leader offers a full range of GPS receivers, base stations and accuracy levels to fit your farm's needs.



SteerCommand Z2:

SteerCommand Z2 provides integrated hydraulic steering directly to vehicle CAN bus, or hydraulic valve for leading autosteer performance.



SteadySteer:

SteadySteer provides autosteer for vehicles without a hydraulic steering valve. Simple integration and transferability are bonuses.

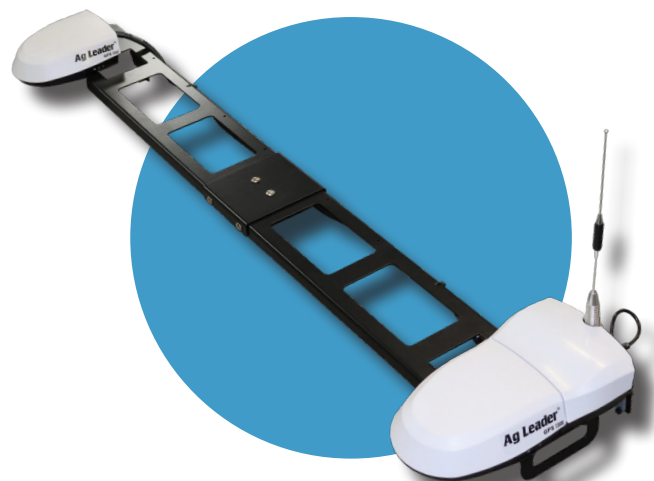

SteerCommand with DualTrac:

Need to take it slow? DualTrac is a high accuracy, dual antenna steering solution for any speed on the farm, down to 0.05 MPH.



POWERFUL PLANTING TOOLS

Planting



Easily identify planter performance issues before they cost you yield in the field. Skips, doubles, singulation and more are quickly identified on the InCommand display.

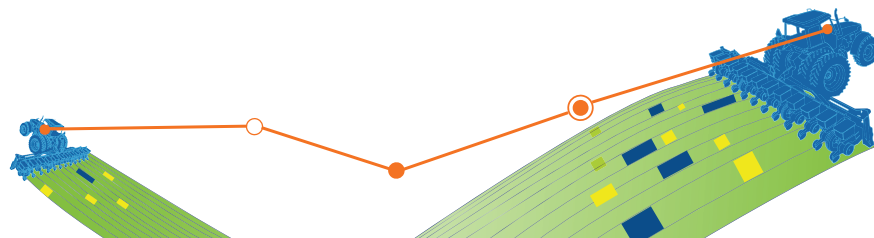

Tools for Every Planter:

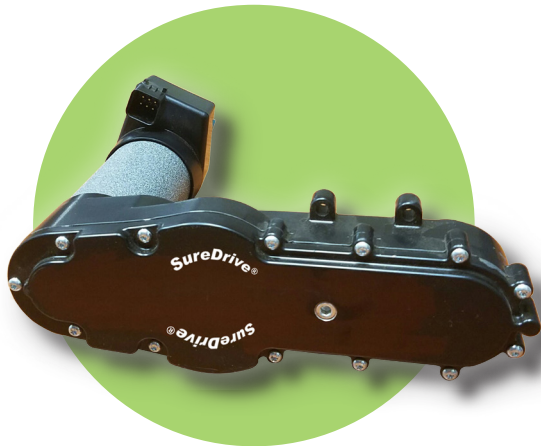

SureDrive:

SureDrive electric drives mount right up to the planter and meter you know and love, gaining you consistent meter drive for variable rate, turn compensation and point row shutoff - all with less maintenance.



SureForce:

SureForce hydraulic downforce with uplift keeps your planter row unit at ideal planting depth, no matter the soil type, conditions or compaction.



SureSpeed:

Accurately place seed at 12 MPH but also at lower speeds. Perfect planting is a priority, speed is a bonus.



SureStop:

Point row clutches such as SureStop and SureVac offer one of the best returns for your precision ag investment. Save seed, save money.



APPLICATION CONTROL THAT MEETS TODAY'S CHALLENGES

Application



InCommand provides effective product application control including section control, variable rate and specific droplet size monitoring. Documentation of when and where products were applied is included for easy recordkeeping.

Precise Application Control:

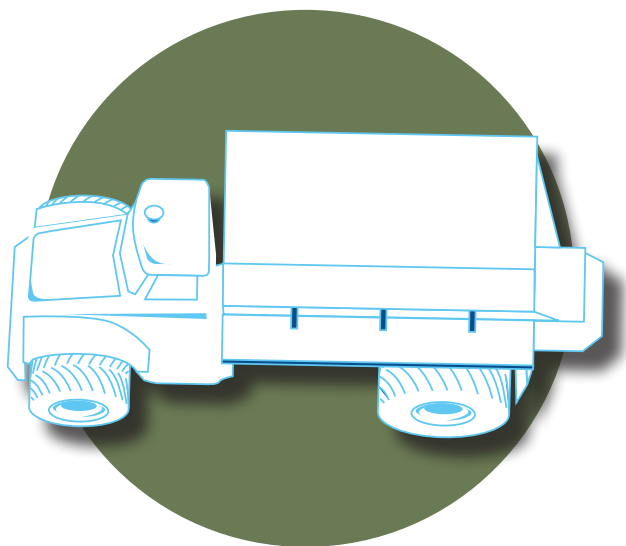

DirectCommand Granular Application:

DirectCommand can control dry product application rate by flat target rate or via prescription and shut off the applicator to minimize overlap.

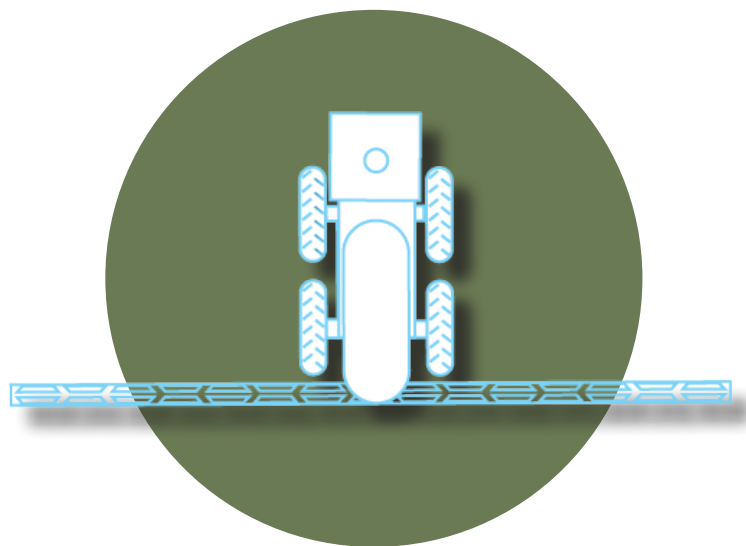

DirectCommand Liquid Application:

Avoid spray drift, ensure proper plant coverage and chemical effectiveness all while saving on chemical costs with boom section shutoff and easy to select application rate control. ISOBUS compatible.

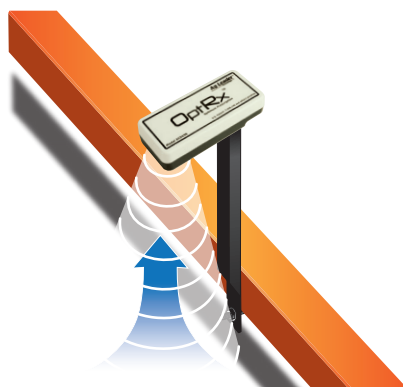

OptRx Crop Sensors:

Use OptRx to easily capture more ROI during a side-dress or top-dress application. OptRx places more nitrogen where crops will respond to and less in areas not crucial to yield.



TRUST NOTHING LESS THAN THE BEST

Harvest



When it comes time for harvest, InCommand with AgFiniti connects your whole operation - across displays, devices and machines. Know live field progress including maps and stats showing yield and moisture. Know the location of each machine and when its time to unload.

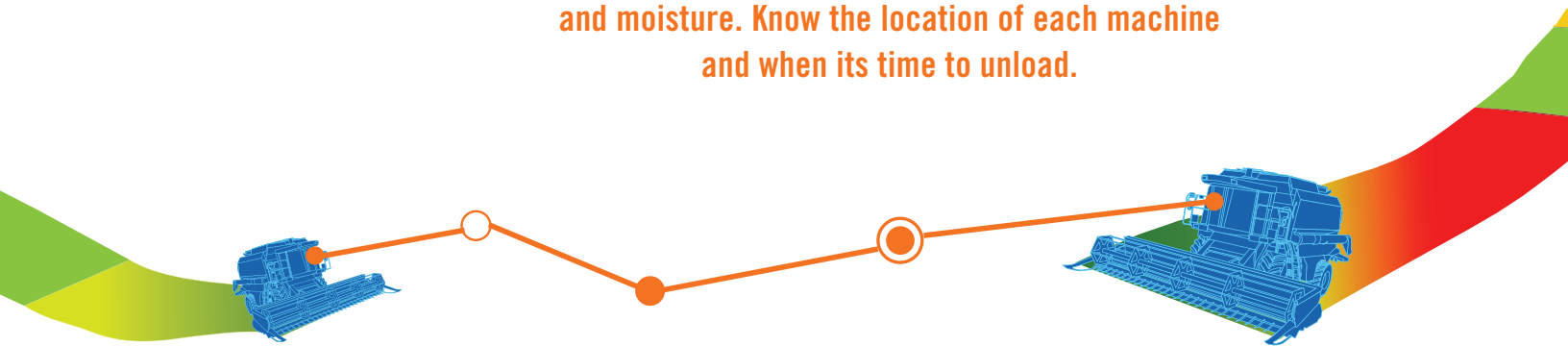

Technology for Harvest:



Yield Monitor:

Ag Leader's technology started the data revolution with the first on-the-go monitor and today it's the most widely trusted yield monitor on the market. Easily see the areas of yield ranges in the field, load background maps of as planted varieties to track their performance or the effectiveness of an application trial or soil type.

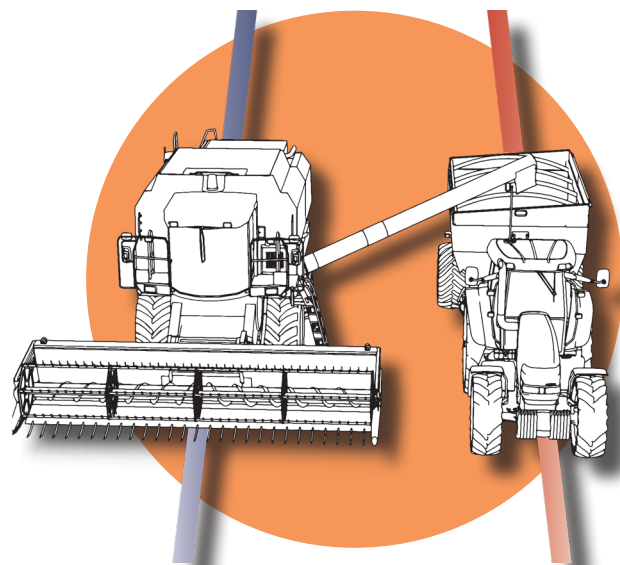

CartACE:

CartACE uses autosteer technology already within the operation to simplify the grain cart operators job. When it's time to unload, the grain cart engages with press of button and automatically steers on a line directly under the combine's auger. Autosteer takes over steering to assist operator with accurately unloading on the go.



DO-IT-YOURSELF TILE INSTALLATION

Water
Management

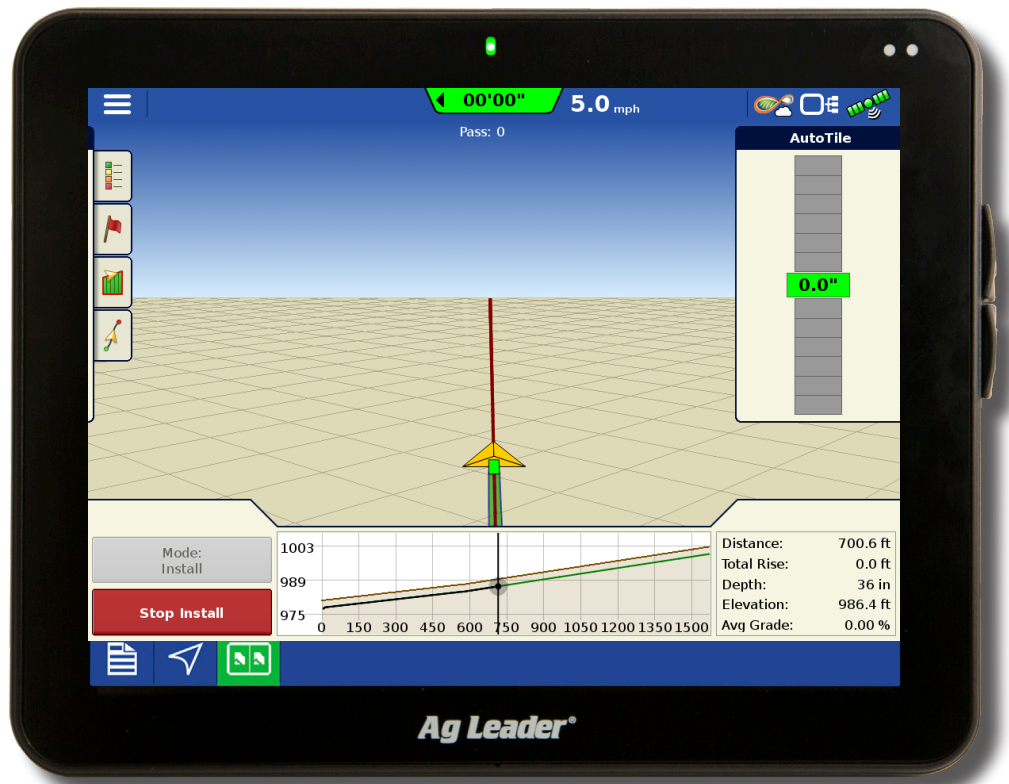

InCommand with Intellislope provides control and accuracy to confidently install field drainage tile on grade and without complicated laser equipment.

Tools for Installing Field Tile:

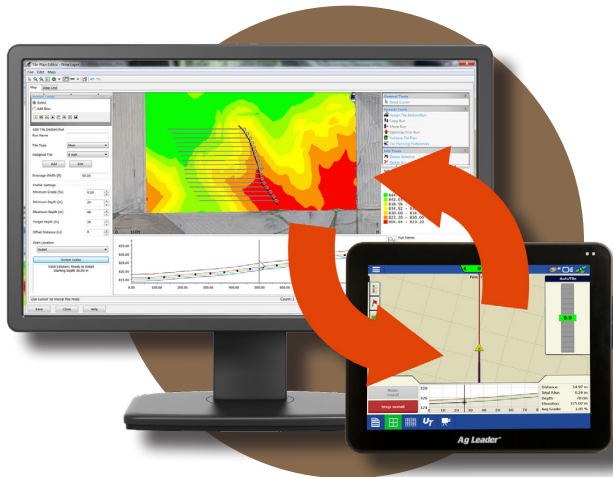

SMS Water Management Software:

Easily design field tile plans based on precise supporting RTK topography layers. Once the plan is complete, SMS will validate the plan to ensure desired drainage. Easily validate that tile runs are sized appropriately to meet drainage needs and ensure proper tile sizing using the Drainage Coefficient tool. The tool's velocity fail-safe ensures tile is laid on a grade-appropriate for the soil texture at the intended depth. Lastly, be sure you've created the best field tile plan by comparing multiple installation plans for cost and drainage efficiency.



Intellislope:

With Intellislope and InCommand, installing field tile is super simple! First, collect a survey of the surface elevation by driving over the path either ahead of time or during installation. Then, enter parameters in the display that ensure tile is placed correctly in order to properly drain soils. Finally, use the plan you created to install your tile. AutoTile will adjust the plow depth automatically to ensure accurate installation.



Soil-Max Plow:

Intellislope pairs nicely with Soil-Max Gold Digger tile plows, a wholly-owned subsidiary of Ag Leader. You can learn more about their plows at soilmax.com



PLAN, MANAGE, PROFIT

Data
Management



Precision farming isn't about spending endless hours crunching numbers and analyzing data. It's about answering questions that can make you more profitable. That's the simple idea behind Ag Leader's industry-leading data management tools - easy-to-use decision-making tools to help you capture the most out of every acre.

Powerful Tools to Discover Profit Opportunities:

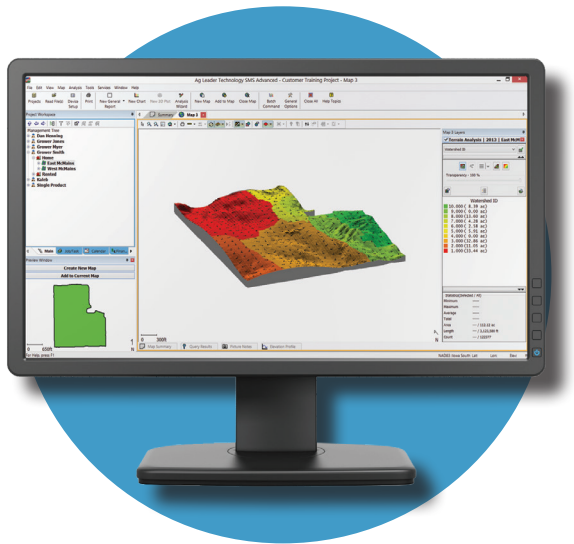

SMS Software:

SMS Software supports the majority of precision ag display file types allowing you to combine and analyze all your data in one place. Powerful analysis tools allow you to dig deeper into your data and identify areas of opportunity including field and guidance line management, soil-sampling, prescriptions, tile planning and more. SMS pairs seamlessly with AgFiniti to allow you to take these insights with you to the field.



AgFiniti:

AgFiniti connects your entire operation including your displays and devices to share your information across your team including trusted advisors. Access both historical and real-time information for on-the-go decision-making and insights into your fields. Quickly and easily generate prescriptions and dig deeper into your information using query tools, Multi-Year Analysis and Comparison Reports.

Ag Leader[®] **Technology**

Ag Leader Technology, Inc. • 2202 S Riverside Dr, Ames, IA 50010 USA • www.agleader.com



Ag Leader reserves the right to make changes in engineering, design and specifications, and improvements, or discontinue manufacture at any time without notice or obligation. Ag Leader®, Ag Leader Technology®, InCommand®, SureDrive®, OptRx®, Intellislope®, AutoTile®, AgFiniti®, SeedCommand®, DirectCommand®, SureForce®, DualTrac®, StableLoc®, DisplayCast®, SmartPath®, SteerCommand®, SureStop®, SureVac®, Gold Digger® and Soil-Max® are registered trademarks of Ag Leader Technology Incorporated. Compass™, AutoSwath™, SmartReport™, SMS™ Software, CartACE™, SureSpeed™, SteadySteer™ are trademarks of Ag Leader Technology Incorporated. Copyright © 2021 Ag Leader Technology Incorporated. All other marks are owned by their respective companies represented herein: TerraStar – NovAtel, Inc.